

Spherical roller bearings, cylindrical and tapered bore

Principal dimensions			Basic load ratings		Speed ratings		Designation
d	D	B	dynamic C	static C0	Reference speed	Limiting speed	
mm			kN		r/min		
200	280	60	651	1040	2200	2400	* SKF Explorer bearing 23940 CCK/W33 *

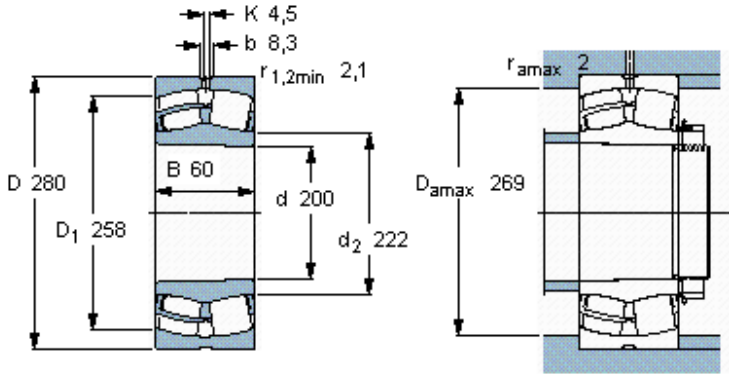

Tapered bore, taper
1: 12

- Calculation factors**
- e 0,19
 - Y_1 3,6
 - Y_2 5,3
 - Y_0 3,6